



For enquiries & suggestions

contact

Krishan K. Sharma

President

International Carrom Federation

11 Orchard Way, Leagrave

Luton LU4 9LT, Bedfordshire, U.K.

Phone & Fax : 0044 (0) 1582-584702

Mobile : 07970000707

E-mail : krishan.k.sharma@btinternet.com

S.K. Sharma

Secretary General

International Carrom Federation

D-92, MMTC Colony, Sri Aurobindo Marg,

New Delhi-110017 INDIA

Phone : +91-11-26569090

Mobile : +91-9810244857

E-mail : icf_sk@yahoo.co.in, aicfiks@indiatimes.com

**FIRST EDITION 1993
SECOND EDITION 2001
THIRD EDITION 2004**

Published by the

International Carrom Federation

D-92, MMTC Colony, Sri Aurobindo Marg,
New Delhi-110017 India

Phone : +91-11-26569090

Mobile : +91-9810244857

© Copyright

International Carrom Federation

No portion of this book may be reproduced or copied or translated in any form or by any means without the written permission of the I. C. F.

International Carrom Federation was formed on
15th October 1988 in India.

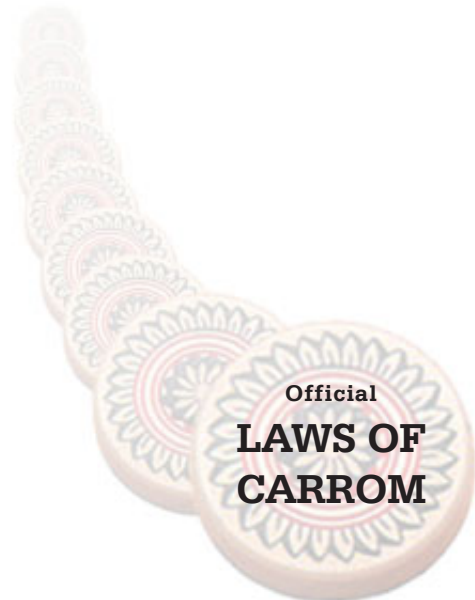

Adopted by

INTERNATIONAL CARROM FEDERATION

2004 Edition

INDEX

S.No.	Contents	Page No.
I.	STANDARD EQUIPMENTS	1
A.	CARROM BOARD	1
A.1.	Playing Surface	2
A.2.	Frames	2
A.3.	Pockets	2
A.4.	Base Lines	3
A.5.	Arrows	3
A.6.	Centre Circle	4
A.7.	Outer Circle	4
B.	CARROMMEN	4
C.	STRIKER	4
D.	STAND or TABLE	5
E.	STOOL or CHAIR	5
F.	POWDER	5
G.	NETS	5
H.	LIGHT	6
II.	INTERPRETATION	6
III.	SITTING POSITION	9

S.No.	Contents	Page No.
IV.	HOW TO STRIKE	9
V.	TOSS	10
VI.	TRIAL BOARD	11
VII.	BREAK	11
VIII.	TURN OF PLAY	12
IX.	HOW TO SCORE	13
X.	CHANGE OF SIDES	14
XI.	FOUL	15
A.	TECHNICAL FOUL	15
B.	FOUL	15
XII.	C/m OVERBOARD	16
XIII.	C/m ROLLING AND OVERLAPPING	17
XIV.	DUES AND/OR PENALTIES	18
XV.	QUEEN	22
XVI.	GENERAL	29
XVII.	LOSS OF ENTIRE MATCH	34
XVIII.	PROTEST	35
XIX.	SCORE CARD	36



I. STANDARD EQUIPMENTS

The term **Standard Equipments** shall mean and include the following :

- | | |
|-------------------|-------------------|
| A. Carrom Board | E. Stool or Chair |
| B. Carrommen | F. Powder |
| C. Striker | G. Nets |
| D. Stand or Table | H. Light |

A. CARROM BOARD

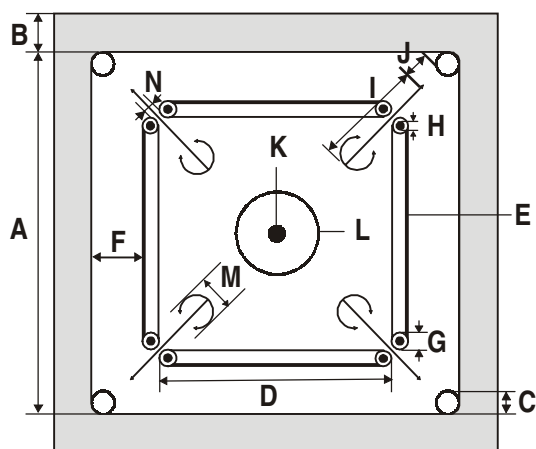

A : 73.50-74cm	F : 10.15cm	J : 5cm
B : 6.35-7.60cm	G : 3.18cm dia	K : 3.18cm dia(0.16cm*)
C : 4.45cm dia(0.15cm*)	H : 2.45cm dia	L : 17cm dia(0.30cm*)
D : 47cm(0.30cm*)	I : 26.70cm max.	M : 6.35cm dia
E : 0.50-0.65cm thick	0.15cm thick	N : 1.27cm

* Variation allowed



A.1. Playing Surface

The playing surface of the Carrom Board shall be of plywood or of any other wood equally smooth and be of not less than 8 mm in thickness and of a minimum of 73.50 cm and a maximum of 74 cm square with its surface completely smooth. A Carrom Board shall be able to have at least three and a half runs of a normally smooth striker of 15 gms weight, when struck with the maximum force, from one of the base lines, to the opposite frame of the Carrom Board.

A.2. Frames

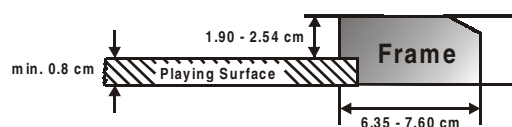

Adjoining the playing surface of the Carrom Board there shall be wooden frames with inside curved corners made of Rosewood or any other hard wood with good resistance, with a minimum height of 1.90 cm and a maximum of 2.54 cm from the playing surface. The breadth of the frame shall not be less than 6.35 cm and not more than 7.60 cm. Suitable bracings shall be provided underneath the playing surface and fastened with the frame.

A.3. Pockets

The pockets of the four corners of the Carrom Board shall be round inwardly and not outwardly and be of 4.45 cm in diameter with admissible variation of not more than 0.15 cm. The piece of plywood adjoining the corners of the frame shall be cut off.



A.4. Base Lines



- a) Two straight lines of 47 cm each in length with admissible variation of 0.30 cm equally distributed on all sides, black in colour, shall be drawn on each of the four sides of the playing surface, parallel to the frame on each side. The lower of these two lines, which shall be between 0.50 cm and 0.65 cm in thickness, shall be 10.15 cm away from the frame and the other one 3.18 cm away from the lower part of the base line.
- b) The base lines shall be closed by circles of 3.18 cm in diameter at both ends. Within this circle a portion of 2.54 cm in diameter shall be coloured in red. These circles shall be called Base Circles. These shall be drawn so as to touch both the base lines and also the upper base lines of the adjacent side when imaginably extended. The distance between the base circle on one side and that of the other may be 1.27 cm approximately.

A.5. Arrows

Four arrows, black in colour, of not more than 0.15 cm thickness shall be drawn at each corner of the Carrom Board at an angle of 45 degrees to any of the adjacent sides and each of them shall pass through the gap between the two Base Circles and point towards the centre of the pocket leaving a clear distance of 5.00 cm from the edge of the pocket. The length of the arrows shall not exceed 26.70 cm. A decorative arch of 6.35 cm in diameter with a pointer at both the ends, drawn at the starting point of the arrows leading towards the pocket, is permissible.

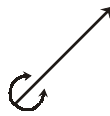

A.6. Centre Circle

Exactly in the centre of the Carrom Board there shall be a circle of 3.18 cm in diameter drawn black in colour with admissible variation of 0.16 cm. It shall be called the centre circle and shall be coloured in red.

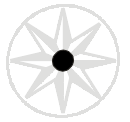

A.7. Outer Circle

A circle of 17.00 cm in diameter with the centre point of the Carrom Board as its centre shall be drawn black in colour with admissible variation of 0.30 cm. It shall be called the Outer Circle. Any decorative design in this circle is permissible.



B. CARROMMEN

The Carrommen used in play shall be of good quality wood and circular in shape. The diameter of a Carromman shall not be more than 3.18 cm and not less than 3.02 cm. A Carromman shall be of not less than 0.70 cm and not more than 0.90 cm in thickness. The edge shall be round and plain. The weight of a Carromman shall not be less than 5.25 grams and not more than 5.50 grams. Thus there shall be nine white, nine black and one red Carrommen, and they shall be uniform. The Carrommen shall have a smooth movement in a flat position on the playing surface of the Carrom Board when struck by a striker of standard specifications.



C. STRIKER

The Striker shall be smooth and round with a diameter of not more than 4.13 cm and weighing not more than 15.00 gms. A Striker made of any material other than Ivory and metal, with the specifications prescribed



above, may be used. A Striker, with metal fixed and visible to the eyes, shall not be allowed. Engraved decent designs on the striker are permissible.

D. STAND OR TABLE

The Stand or Table on which the Carrom Board is placed for play shall not be less than 63.00 cm and not more than 70.00 cm in height. The Carrom Board, when placed on it, shall not be uneven or shaky. However, padding below the Carrom Board and/or the Stand or Table on which the Carrom Board is placed, may be used to make the playing surface of the Carrom Board level and firm as far as possible.

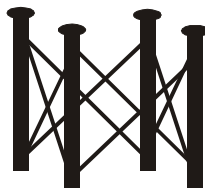

E. STOOL OR CHAIR

The Stool or Chair on which the player sits for playing shall not be less than 40.00 cm and not more than 50.00 cm in height. The Chair, if used, shall be armless.



F. POWDER

The powder used shall be of high quality to keep the playing surface smooth and dry. The powder shall not be wet. Pouches/Containers filled with powder shall be used to spread the powder evenly over the playing surface.

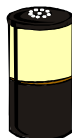

G. NETS

The pockets shall be fully covered from beneath by nets fixed at the bottom of the Carrom Board. Each net shall have the capacity of holding at least 10 C/m.



H. LIGHT

The light shall be hung/fitted at a convenient height above the Carrom Board so that when a conical or square shade, preferably of metal, is used, the light shall fall only on the Carrom Board including the frame. The shade shall be one with the inner side completely snow-white in colour. The bulb used, preferably transparent white, shall be between 60 and 100 watts. However, the height of the light can be altered at the request of a player in such a manner that the naked light does not strike the eyes of the player/s.

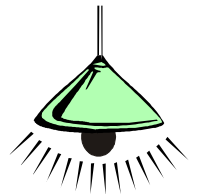

II. INTERPRETATION

In these Laws, unless there is anything repugnant to the subject or context, the terms given below shall have the following interpretations:

- 1) 'Laws' shall mean the Laws of Carrom.
- 2) a) 'Proper' shall mean in accordance with the Laws.
b) 'Improper' shall mean contrary to the Laws.
- 3) 'C/B' Shall mean Carrom Board
- 4) 'C/m' shall mean Carromman/ Carrommen.
- 5) 'Board' shall mean from the commencement of a board, after Umpire calls 'Play' till its completion on pocketing of last C/m of any player.
- 6) 'Break' shall mean the first stroke of a board.
- 7) 'Finish' shall mean the completion of the board.
- 8) 'Player' shall mean a Carrom player



- 9) 'Placing' shall mean keeping the penalty and/or due C/m in a flat position on the playing surface within the outer circle only by the player permitted to do so as per the Laws. The Queen and/or the jumped c/m shall always be placed by the Umpire in the Centre Circle as per the Laws.
- 10) 'Pocketing' shall mean putting C/m and/or Queen into the pocket by a proper/improper stroke.
- 11) 'Push' shall mean a jerk or sudden motion of the elbow of the playing 'hand' instead of striking the Striker with the finger.
- 12) 'Queen' shall mean the red C/m.
- 13) 'Due' shall mean pocketing the Striker with or without C/m and/or Queen, and/or any outstanding penalty and/or due c/m against the player as the case may be.
- 14) 'Penalty' shall mean punishment for infringement or violation of the Laws.
- 15) 'Covering' shall mean pocketing one of his own C/m by a player in the same or immediate subsequent stroke, when or after Queen is pocketed.
- 16) 'Shot' shall mean a pair or cannon.
 - a) 'Pair' shall mean two C/m or one C/m and Queen facing the general direction of the pocket with a space in between them.
 - b) 'Cannon' shall mean two C/m or one C/m and Queen facing the general direction of the pocket without any space in between them.
- 17) 'Thumbing' shall mean taking a stroke with the thumb.



- 18) 'Turn' shall mean the right to strike.
- 19) 'Chief Referee' shall mean an official appointed to administrate, supervise, control and give decisions on all matters referred to him in the course of a match.
- 20) 'Umpire' shall mean an official appointed to supervise and/or control a match.
- 21) a) 'Opponent' in singles shall mean the player presently not having his turn to play.
b) 'Opponent' in doubles shall mean the player sitting on the left and/or right side of the player presently having his turn to play.
- 22) 'Hand' shall mean the portion of the playing hand from the fingers up to the wrist.
- 23) 'Finger' shall mean the portion of the nail side of a finger up to the second joint.
- 24) 'Imaginary Lines' shall mean the lines drawn in extension of the arrows between the Base Circles.
- 25) 'Stroke' shall mean hitting the C/m by the Striker directly or indirectly.
- 26) a) 'White Slam' shall mean pocketing all the nine white C/m and the Queen as per the Laws in the first turn of play. It may also be called 'Break to Finish'.
b) 'Black Slam' shall mean pocketing all the remaining black C/m with or without Queen as per the Laws in the first turn of play.

NOTE: *Words implying singular shall include plural and words implying masculine shall refer to the feminine also.*



III. SITTING POSITION

- 27) In singles, the players shall sit opposite to each other.
- 28) In doubles, the partners shall sit opposite to each other, occupying all four sides.
- 29) Position adopted for sitting by a player before taking his turn to strike may be changed at any time provided the chair or stool on which he is sitting is not lifted, moved and/or disturbed during his turn of play.
- 30) a) During the 'board' no part of the body of a player, except the playing arm shall touch the Carrom Board, stand or table on which the C/B is placed.
b) However, wearing/clothing, ring, bangles and/or watch worn by a player are exempted during his turn of play, but these should not touch the playing surface.
- 31) Use of any material to raise and/or adjust the height of the seat is permissible after the completion of the board only, provided the height of the seat so raised does not exceed 50 cm.
- 32) No part of the body, except the 'hand' of the player shall go beyond the imaginary lines of the arrows.

IV. HOW TO STRIKE

- 33) The Striker shall be struck and not pushed.
- 34) The stroke shall be made with the finger with or without the support of other fingers.
- 35) Any hand may be used in play.



- 36) While making a stroke, the 'hand' may touch the playing surface.
- 37) a) While making a stroke, the elbow of the playing 'hand' shall not come within the playing surface nor shall extend beyond the imaginary lines of the arrow.
b) The 'hand' may, however, cross the arrow.
- 38) a) While making a stroke, taking support of the Stool or Chair, Stand or Table of the C/B and/or keeping the legs on the rim of the stand/table, by the player, is not permissible.
b) However, hands may rest on his body and legs may rest on the rim of the stool or chair, on which he sits.

V. TOSS

- 39) a) There shall be a toss by the Umpire at the commencement of each match. The toss shall be by spin of coin or by means of calling the C/m. The either player/pair, winning the toss, shall have the choice of side or the option to strike first. If the winner decides to have the choice of side, he shall communicate the same to the Umpire, who shall instruct the loser to sit first.
b) In doubles, the pair winning the toss shall have the option as above.
c) If, however, break is chosen by the winner of the toss, the choice of side shall lie with the loser, and the winner shall have to sit first.
d) Once the losers have sat down, they cannot interchange. This order of sitting shall continue throughout the match.

**VI. TRIAL BOARD**

- 40) There shall be two trial boards only after the toss and before the start of the match, one for each player or pair.

VII. BREAK

- 41) a) Before the break, the C/m are so arranged, in a flat position, that the Queen shall occupy the Centre Circle and the rest of the C/m are placed around the Queen in the first row keeping the Black and White C/m alternately. In the second row, three white C/m will form the shape "Y," with the white C/m in the first row. The remaining space is filled up by placing black and white C/m alternately. All c/m so arranged, should be in compact round, touching each other, within the Outer Circle. A player may use his fingers or striker to keep the C/m intact.



- b) The C/m should be arranged for the break with least possible loss of time after each board.
- 42) Break is taken by a player, who has chosen to strike first.
- 43) The player who is to break shall have the white C/m during that board leaving the black C/m to his opponent. The Queen shall be the common C/m.
- 44) Break is considered to have been made, if the Striker touches any of the C/m even slightly.
- 45) a) Break is not considered to have been made if no C/m is touched by the Striker in its usual run or jumping out. In that case, a maximum of two more chances shall be allowed.



- b) If after permissible number of chances, no C/m is touched, the right to Break shall be lost and the turn to play shall pass on to the opponent who shall have black C/m for play but no re-arrangement of C/m already arranged, shall be permitted. The above condition will prevail till the break is effected.

- c) If a player in his attempt to break, plays an improper stroke or pockets his striker without touching any of the c/m, he shall lose his turn. However, due/penalty shall not be applicable.

- 46) The break shall be taken only after the Umpire calls 'Play' and the stroke shall be made within 15 seconds of such call. The play shall be deemed to have begun from the moment the Umpire calls 'Play'.
- 47) If the break is made before the Umpire calls 'Play', all his C/m and/or Queen pocketed shall be taken out for placing and a foul declared. The player shall lose his turn.

VIII. TURN OF PLAY

- 48) As long as a player pockets his own C/m and/or Queen in accordance with the Laws, his turn shall continue. Otherwise it shall pass on to the opponent.
- 49) a) i) In the first game the player who chooses to break the first board shall have the white C/m. The turn to break shall pass alternately during the game.
- ii) In the second game the player who did not have the first turn to break shall have his turn first.
- iii) In the third game, the turn to break passes on to the first player.
- b) In Doubles, however, the turn passes on to the player sitting to the right hand side of the player who had his turn.



- 50) A player shall not take more than 15 seconds for making a stroke from the moment the C/m/Queen/Striker has come to rest and the striker is picked up by the opponent and/or after observing the time limit for placing the C/m and/or Queen and/or foregoing due/penalty C/m, if any.
- 51) If the turn is availed by a player who plays out of turn, before the Umpire could control, he shall lose the board by the number of C/m and Queen as were on the C/B at the time of making the first out of turn stroke. If the above remains unnoticed by the Umpire or opponent, till the next stroke is taken, the turn shall be allowed and the next turn shall be as per the Laws.

IX. HOW TO SCORE

- 52) a) The player who completes pocketing all his C/m first wins the board.
- b) The value/points are as follows:
- i) Queen : 3 points up to and including 21 points.
- ii) C/m : 1 point each.
- 53) a) The number of C/m of the opponent on the C/B shall be the points gained by that player in that board.
- b) The player is entitled to be credited with the value of the Queen, only if he wins the board.
- c) The player who loses the board is not credited with the value of the Queen, even if he has pocketed and covered the Queen.
- 54) The player loses the advantage of getting the credit of an additional 3 points for covering the Queen, once he has reached the score of 22 points.



- 55) The maximum number of points that can be scored in a board is 12 only. Any Due and/or penalty C/m shall automatically be written off.
- 56) a) A game shall be of 25 points or eight boards. The player who reaches 25 points first or leads at the conclusion of the eighth board shall be the winner of the game.
- b) Up to and including the pre-quarter final rounds, each game shall be decided on the basis of eight boards. In case the score is equal at the end of the eighth board, an extra board shall be played to decide the winner. Before the extra board, there shall be a toss to choose break only.
- 57) All matches shall be decided only by the best of three games.

X. CHANGE OF SIDES

- 58) In Singles, the change of sides by the players shall be made in the opposite direction at the conclusion of each game.
- 59) In Doubles, the change of sides by the players shall be made to the next right hand side, at the conclusion of each game.
- 60) a) In the third game for matches up to and including Pre-quarter finals, the change of sides shall be made after the fourth board or after any player/pair has scored 13 points whichever is earlier.
- b) From Quarter-Finals onwards the change of sides shall be made only after 13 points have been scored by any player/pair.
- c) The change of sides, remaining unnoticed by the Umpire or any player, shall take place as and when noticed, but after completion of that particular board.



61) The players shall not take more than two minutes to change sides.

XI. FOUL

62) In general, any act of violation of Laws or anything done contrary to what is stated specifically or implied (as understood commonly) in these Laws, shall be broadly classified as:

**A. TECHNICAL FOUL &
B. FOUL**

A. TECHNICAL FOUL

- 63) a) Any act of violation of the Laws committed by the player before the first stroke of his turn shall be deemed as a Technical Foul. A Technical Foul shall entail one C/m of the offending player being brought out for placing by the opponent and his turn shall continue.
- b) Any act of violation of the Laws committed by the player presently not having his turn shall also be deemed as a Technical Foul. A penalty shall be imposed as per Rule 63 (a).

B. FOUL

- 64) a) Any act of violation of the Laws committed by the player during or after the first stroke of his turn shall be deemed as Foul. A Foul shall entail one C/m of the offending player being brought out for placing by the opponent and the turn to play shall be lost.
- b) While pocketing the C/m and/or Queen, if a Foul is committed, the number of C/m and/or Queen so pocketed with an additional C/m shall be brought out for placing and the turn of the player shall be lost.



XIII. C/m ROLLING AND OVERLAPPING

- 67) If c/m and/or Queen stands on its rim, it shall be allowed to remain as it is.
- 68) If two C/m and/or Queen overlap each other, they shall be left undisturbed.
- 69) a) If the Striker rests on c/m and/or Queen, the Striker shall be removed without disturbance to the C/m and/or Queen by the Umpire. If disturbed, the original position of the c/m and/or Queen shall be restored, as far as possible, by the Umpire.
- b) If this happens at the mouth of the pocket and in the process of removal of the Striker the C/m and/or Queen lose its centre of gravity and fall into the pocket, they shall be deemed to have been pocketed.
- 70) a) If C/m and/or Queen rest on the striker, the Striker shall be removed by the Umpire by lifting the C/m and/or Queen and replacing them, as far as possible, in the original position where they would rest if the Striker was not there.
- b) If, however, this happens at the mouth of the pocket and in the process of removal of the c/m and/or Queen, the Striker loses its centre of gravity and falls into the pocket, it shall be deemed to have been pocketed. A Due shall be declared to be imposed as per the Laws.
- 71) If a C/m resting perilously at the mouth of the pocket and actually falls into the pocket for any reason, it shall be considered to have been properly pocketed.



XII. C/m OVERBOARD

- 65) a) If a C/m and/or Queen jump out of the playing surface, the jumped C/m and/or the Queen shall be placed by the Umpire in the Centre Circle, if space permits, covering it fully or the maximum portion of it that is available.
- b) If both the Queen and a c/m jump in the same stroke preference shall be given to place the Queen first and the jumped c/m shall be placed, touching the Queen, in the opposite direction of the player presently having his turn.
- c) If both White and Black c/m jump in the same stroke, preference shall be given to place the c/m of the player who made that stroke first and the other c/m shall be placed, touching the first c/m in the manner described in Rule 65(b).
- d) If more than 2 c/m jump in the same stroke, the placing of the first 2 c/m shall be in accordance with Rule 65(b) and Rule 65(c). The rest of the c/m shall be placed, touching the first 2 c/m, as far as possible.
- 66) a) If c/m and/or Queen jump out and fall back on the playing surface, the c/m and/or Queen shall be placed by the Umpire in the Centre Circle as per Laws. The position of the disturbed c/m, if any, shall be corrected by the Umpire, as far as possible, at his discretion.
- b) If, however, c/m and/or Queen jump out and fall back on the playing surface after hitting the shade, bulb or light fittings, it shall be considered to have naturally travelled. Disturbed c/m, if any, shall not be rearranged.



XIV. DUES AND/OR PENALTIES

- 72) a) If in a proper stroke a player pockets his Striker alone, his turn shall be lost and one of his C/m will be taken out as penalty by his opponent for placing. Such penalty C/m shall be called 'Due'.
- b) If in an improper stroke a player pockets his Striker alone, his turn shall be lost and two of his C/m will be taken out by his opponent for placing. Such penalty C/m shall be called 'Due and foul'.
- c) If this happens before any of his C/m is pocketed the penalty and Due shall remain outstanding and shall be taken out as soon as they are available.
- 73) If a player pockets the Striker with his own C/m by a proper stroke, the number of C/m so pocketed, with a Due C/m, shall be taken out for placing and the player shall continue his turn.
- 74) If a player pockets the Striker with the C/m of his opponent by a proper stroke, the C/m so pocketed shall be deemed to have been pocketed. The Due as per Rule 72(a) shall be taken out for placing and the player shall lose his turn.
- 75) If a player pockets the Striker with C/m of his own and of his opponent by a proper stroke, the number of his own C/m so pocketed, with a due C/m shall be taken out for placing by the opponent and the player shall continue his turn.
- 76) If a player pockets the C/m of his opponent by an improper stroke, the C/m so pocketed shall be deemed to have been pocketed. The 'Penalty' C/m shall be taken out for placing by the opponent and the player shall lose his turn.
- 77) a) If a player pockets his own C/m by an improper stroke, the C/m so pocketed with a Penalty C/m shall be taken out for placing by the opponent and the player shall lose his turn.



- b) If a player pockets his own C/m with the striker by an improper stroke, the C/m so pocketed with two C/m, one as Due and the other for Penalty shall be taken out for placing by the opponent and the player shall lose his turn.
- 78) a) Due or penalty C/m shall be taken out for placing immediately after being available, but only after the completion of the stroke, though it may be during the turn of the same player.
 - b) i) In Doubles the Due and/or penalty C/m shall always be taken out for placing by the player who is sitting on the right hand side of the player having his turn at the time of availability of C/m.
 - ii) If, however, during the turn of a player, he pockets the C/m of the opponent with or without his C/m and the Due and/or penalty C/m becomes available, the player himself shall take out the C/m for placing.
- 79) a) If Due and/or penalty C/m is available for placing but sufficient space is not available, the player who has to place the C/m shall be permitted to do so immediately after space becomes available.
 - b) In Doubles, however, if the eligibility to place the Due and/or penalty C/m, has passed on to the partner, the partner alone shall have the right to take out and place the C/m.
- 80) If space is available for placing the Due and/or penalty C/m, but the player who has to place the C/m does not desire to risk a Foul, he shall lose his chance to place and his claim for placing shall stand forfeited.



- 81) If the space becomes available for placing the Due and/or penalty C/m, during the turn of the player, eligible to place, the placing shall be made immediately.
- 82) a) While placing the Due and/or penalty C/m, if a player places his own C/m by mistake, it has to be rectified if pointed out by the umpire or the opponent. A Foul shall be declared as per the Laws.
 - b) If not noticed either by the Umpire or the opponent before the next stroke is made, the C/m so placed shall be regarded as valid.
- 83) If more than one C/m are to be placed by a player as Due and/or penalty, the C/m available shall be placed immediately and rest of the C/m have to be placed as soon as available. If on availability, rest of the C/m is/are not placed by the player concerned before the next stroke is made and the same remains unnoticed by the opponent/ Umpire the due shall be deemed to have been forfeited.
- 84) a) Placing shall be considered as complete once the finger is removed from the C/m provided the C/m placed is inside the Outer Circle.
 - b) However, while placing Due and/or penalty C/m holding of any other C/m and/or striker is not permitted.
- 85) If a player places or moves the Due and/or penalty C/m away from the Outer Circle, he shall be asked to place the C/m inside the Outer Circle. A Foul shall be declared as per Laws.
- 86) While placing the Due and/or penalty C/m the player should not move any other C/m and/or Queen. The C/m so placed shall not disturb any other C/m. If it so happens, the same shall be replaced by the Umpire in the original position, as far as possible. A Foul shall be declared against the offending player as per the Laws.



- 87) a) A player may choose to forego the Due and/or penalty C/m in toto only and not partially. Such decision shall be communicated to the Umpire within 15 seconds, failing which the right to place the Due and/or penalty C/m shall be forfeited.
 - b) The additional points on completion of the Board available on demand, may at the option of the beneficiary be demanded fully/partially.
- 88) a) The time limit for placing Due and/or penalty C/m shall be 15 seconds after the announcement made by the Umpire.
 - b) If the placing of all the due and/or penalty C/m is not completed within the stipulated period, the C/m already placed may be ordered to be removed and a foul declared against the offender.
- 89) a) Due and/or penalty C/m cannot be set off against each other.
 - b) Due and/or penalty C/m shall not be placed covering the Centre Circle wholly or partially. If placed, the player shall be asked to rectify. A Foul shall be declared against the offending player as per the Laws.
- 90) In Doubles, a player shall not take out the penalty and/or Due C/m for his partner, who has to place it. In case his partner does not find the required C/m in the pockets adjoining his side, he shall request the Umpire to provide, specifying the colour and number of C/m he needs for placing.
- 91) During the course of the Board, if a player gets up from the seat during his turn or of his opponent's turn, for any reason, he shall lose the Board with the number of his C/m and/or Queen lying on the Board. If the score of the opponent is 22 or more he shall lose the Board by the number of C/m only.



XV. QUEEN

- 92) A player has the right to pocket the Queen and to cover it provided a c/m of his own has already been pocketed.
- 93) The Queen shall be placed by the Umpire only in the Centre Circle. While placing so, however, if a shot is automatically formed, it cannot be altered. 
- 94) If the Centre Circle is partially or completely covered by other C/m, the Queen shall be placed so as to occupy most of the uncovered portion or in any position adjacent to the Centre Circle in such a way so that it is not easy to pocket for the player having his turn. The placing of the Queen by the Umpire, in such a situation, shall be final.
- 95) a) If the Queen is pocketed before any C/m of the player is pocketed, the Queen shall be taken out for placing and the player shall lose his turn.
 - b) If a player pockets the Queen, while there is a Due against him, the Queen shall be taken out for placing and the player shall lose his turn.
 - c) However, if after recovery of Due and/or penalty, all the nine C/m are on the C/B, a player shall have the right to pocket the Queen and to cover it.
 - d) If, at the break or in a subsequent stroke when all his nine C/m are on the C/B, the Queen is pocketed along with the Striker, the Queen shall be taken out for placing and a Due shall be declared. The player shall lose his turn.



- 96) If the Queen is pocketed by a stroke and is not covered, the Queen shall be taken out for placing. If not noticed by the Umpire or by the opponent, before the next stroke is made, the Queen shall be recorded as properly covered.
- 97) a) If the Queen and the C/m of a player are pocketed together in one stroke, the Queen shall be considered covered.
 - b) However, at the Break and/or in any subsequent stroke, when all nine C/m of the player are on the C/B, if the Queen and one of the C/m are pocketed together, the Queen has to be covered. If more than one C/m and the Queen are pocketed together, the Queen shall be considered covered.
- 98) a) If the Queen, C/m of a player and the Striker are pocketed together by a proper stroke the Queen and the C/m so pocketed with an additional one as Due, shall be taken out for placing and the player shall continue his turn.
 - b) If the Queen, C/m of a player and the Striker are pocketed together by an improper stroke, Queen and the C/m so pocketed with additional two C/m as due and penalty shall be taken out for placing and the player shall lose his turn.
- 99) a) If the Queen and the Striker are pocketed together by a proper stroke, the Queen shall be taken out for placing by the Umpire. An additional C/m shall be taken out for placing by the opponent and the player shall continue his turn.
 - b) If the Queen and the Striker are pocketed together by an improper stroke, the Queen shall be taken out by the Umpire for placing. Additional two C/m shall be taken out for placing by the opponent and the player shall lose his turn.



- b) While covering the Queen, if a player pockets the last C/m of his own together with the last C/m of his opponent by an improper stroke the opponent shall win by three points. If the score is 22 or more he shall win by one point. if demanded, an additional point for the improper stroke shall be awarded to the opponent.
- 103) a) While covering the Queen, if a player pockets the last C/m of his opponent by a proper stroke, he shall lose the Board by the number of his C/m lying on the C/B together with the points for the Queen. If the score of the opponent is 22 or more, he shall lose by the number of C/m only.
 - b) While covering the Queen, if a player pockets the last C/m of his opponent by an improper stroke, he shall lose the Board by the number of his C/m lying on the C/B together with the points for the Queen. If the score of the opponent is 22 or more, he shall lose by the number of C/m only. if demanded, an additional point shall be awarded to the opponent.
- 104) a) If a player pockets the Queen along with his last C/m and the last C/m of his opponent by a proper stroke, the player shall win the Board by 3 points. If the score is 22 or more he shall win by 1 point.
 - b) If a player pockets the Queen along with his last C/m and the last C/m of his opponent by an improper stroke, the opponent shall win the board by 3 points. If the score is 22 or more he shall win by 1 point. If demanded one additional point shall be awarded.



- 100) a) While covering the Queen, if the Striker alone is pocketed by a proper stroke, the Queen shall be taken out placing. A C/m of the offending player shall be taken out as Due for placing by the opponent and the player shall lose his turn.
 - b) While covering the Queen, if the Striker alone is pocketed, by an improper stroke the Queen shall be taken out for placing. Two C/m of the offending player shall be taken out as Due and Penalty for placing by the opponent and the player shall lose his turn.
- 101) a) While covering the Queen by a proper stroke, if a player pockets the striker along with his C/m, the C/m so pocketed plus one C/m as Due shall be taken out for placing by the opponent. The player shall however, continue his turn. If in that subsequent stroke no C/m of the player is pocketed, the Queen shall not be considered to have been covered and it shall be taken out for placing.
 - b) While covering the Queen, if a player pockets his Striker along with his C/m by an improper stroke, the C/m so pocketed plus two C/m as due and penalty shall be taken out for placing by the opponent and the player shall lose his turn. The Queen shall be taken out for placing by the Umpire.
- 102) a) While covering the Queen a player pockets the last C/m of his own together with the last C/m of his opponent by a proper stroke, he shall be awarded 3 points. If the score is 22 or more he shall win by 1 point.



- 105) a) If a player pockets the last C/m of his own and of his opponent by a proper stroke while the Queen is on the C/B, the opponent shall be awarded 3 points. If the score is 22 or more he shall be awarded only 1 point.
 - b) If a player pockets the last C/m of his own and of his opponent by an improper stroke while the Queen is on the C/B, the opponent shall be awarded 3 points. If the score is 22 or more he shall be awarded only 1 point. If demanded, the opponent shall be awarded 1 additional point.
- 106) a) If a player pockets the last C/m of his opponent by a proper stroke, when the Queen is on the C/B, he shall lose the Board by the number of his own C/m lying on the C/B together with the points for the Queen. If the opponent's score is 22 or more he shall lose by the number of C/m only.
 - b) If a player pockets the last C/m of his opponent by an improper stroke when the Queen is on the C/B, he shall lose the Board by the number of his own C/m lying on the C/B together with the points for the Queen. If the opponent's score is 22 or more he shall lose the Board by the number of C/m only. If demanded, the opponent shall be awarded one point in addition.
- 107) a) If a player pockets his last C/m by a proper stroke leaving the Queen on the C/B, he shall lose the Board by 3 points. If the opponent's score is 22 or more he shall lose by one point.
 - b) If a player pockets his last C/m by an improper stroke leaving the Queen on the C/B, he shall lose the Board by 3 points. If the opponent's score is 22 or more he shall lose by one point. If demanded, the opponent shall be awarded one additional point.



- 108) a) If a player pockets his last C/m along with the Striker leaving the Queen on the C/B by a proper stroke, he shall lose the Board by 3 points. If the score of the opponent is 22 or more, he shall lose by one point. One additional point for the pocketed striker shall be awarded, if demanded by the opponent.
- b) If a player pockets his last C/m along with the Striker leaving the Queen on the C/B by an improper stroke, he shall lose the Board by 3 points. If the score of the opponent is 22 or more, he shall lose by one point. If demanded, the opponent shall be awarded two additional points.
- 109) a) If a player pockets the Queen, his last C/m, the last C/m of his opponent by a proper stroke together with the Striker, the player shall lose the Board by 3 points. If the score of the opponent is 22 or more, he shall lose by one point. One additional point for the pocketed striker shall be awarded, if demanded by the opponent.
- b) If a player pockets the Queen, his last C/m, the last C/m of his opponent together with the Striker by an improper stroke, the player shall lose the Board by 3 points. If the score of the opponent is 22 or more, he shall lose by one point. If demanded, the opponent shall be awarded two additional points.
- 110) a) If a player pockets the last C/m of his own and of his opponent together with the Striker by a proper stroke he shall lose the Board by one point, if the Queen has been covered by him. One additional point for the pocketed Striker shall be awarded if demanded by the opponent.



- 113) If the Queen resting perilously at the mouth of the pocket and actually falls into the pocket for any reason, it shall be considered to have been (duly) pocketed.
 - 114) A player shall not utilise the due and/or penalty C/m to make a shot with the Queen. If utilised, he shall be asked by the Umpire to rectify. A Foul shall be declared as per the Laws.
- XVI. GENERAL**
- 115) A stroke shall be taken by means of a Striker only. The Striker shall be brought by the player and certified by the Chief Referee/Umpire before play.
 - 116) While taking a stroke, if the Striker jumps over the C/B, the turn of the player shall continue if he pockets his own C/m and/or Queen in that stroke.
 - 117) A changed new Striker, duly approved by the Chief Referee/ Umpire, shall be allowed in a match, after the particular Board is completed. However, if in the middle of the board, the Striker is damaged, it is permitted to change the same only after completion of that particular stroke.
 - 118) a) Once set, the position of the C/B shall not be changed in the middle of the match.
 - b) However, the sole authority to make any change after examination, on an appeal by any player, lies with the Umpire.
 - 119) The C/B, stand or table on which the C/B is placed, allotted for a match can be changed only after the completion of the Board. The sole authority for deciding the condition of the C/B, stand or table rests with the Umpire.



- b) If a player pockets the last C/m of his own and of his opponent together with the Striker by an improper stroke, he shall lose the Board by one point, if the Queen has been covered by him. Two additional points shall be awarded, if demanded by the opponent.
- 111) a) If a player pockets the last C/m of his opponent along with the Striker leaving the Queen on the C/B by a proper stroke, he shall lose the Board by the number of his C/m lying on the C/B plus the value of the Queen. If the score is 22 or more, he shall lose by the number of C/m only. One additional point for the pocketed Striker shall be awarded, if demanded by the opponent.
- b) If a player pockets the last C/m of his opponent along with the Striker leaving the Queen on the C/B by an improper stroke, he shall lose the Board by the number of his C/m lying on the C/B plus the value of the Queen. If the score is 22 or more he shall lose by number of his C/m only. If demanded, the opponent shall be awarded two additional points.
- 112) a) If a player pockets the last C/m of his own and of his opponent together with the Striker by a proper stroke, he shall lose the Board by 3 points, if the Queen has been covered by the opponent. If the score of the opponent is 22 or more, he shall get one point. One additional point shall be awarded, if demanded by the opponent.
- b) If a player pockets the last C/m of his own and of his opponent together with the Striker by an improper stroke he shall lose the Board by 3 points, if the Queen has been covered by the opponent. If the score of the opponent is 22 or more he shall get one point. Two additional points shall be awarded, if demanded by the opponent.



- 120) Any damaged C/m, if appealed for replacement, shall be replaced by the Umpire in the original position of the damaged C/m as far as possible.
 - 121) a) The time count stops when there is an appeal to the Umpire by a player, during the play. The play shall not continue unless the Umpire has ordered 'Play'.
 - b) The player who violates this, shall lose the entire board with the number of his C/m lying on the C/B with the points of the Queen, as per Laws, if it is lying on the C/B.
 - 122) a) The powder shall be applied evenly, by the player having the turn, over the playing surface before break. The use of powder shall be neither excessive nor scanty.
 - b) i) The powder shall not be applied or removed after the Umpire has announced 'Play'.
 - ii) Any wilful attempt to remove or wipe powder from the playing surface shall not be permitted.
 - iii) The removal of powder from the playing surface by way of blowing, wiping or any other way shall not be permitted.
- For any infringement, as stated above in 122(b) (i), (ii) & (iii) a Foul shall be declared against the offending player as per the Laws.
- c) However, excess powder, if any, along the Base Lines and Base Circles of his side, may be removed, by a player during his turn of play with the help of the Striker only.
 - d) The Umpire shall have the right to control the even application of powder on the playing surface.



- e) The Umpire should be requested for removal of dust, insects, etc., from the C/B during the course of play.
- 123) A stroke is considered completed only after the Striker, C/m and/or Queen disturbed by the Striker comes to rest. The Striker shall be removed by the player from the C/B immediately after the stroke is completed. The Umpire may assist on request.
- 124) a) As long as a player pockets his own C/m and/or Queen, the time count starts as soon as the stroke is completed.
b) However, in a stroke, when a player fails to pocket his C/m and/or Queen, the time count for the opponent shall start only after the Striker has been removed from the C/B.
c) A player shall not make the stroke before the opponent picks up his Striker from the C/B.
- 125) a) When a player pockets the C/m of his opponent knowingly or unknowingly, the Umpire shall stop the player from playing further.
b) If unnoticed by the Umpire or by the opponent, the C/m pocketed shall be considered to have been properly pocketed. The turn of the player shall be lost as and when noticed.
- 126) a) The player shall not hit, tap or disturb the C/B wilfully or otherwise. If done, a Foul shall be declared against the offending player, as per the Laws.
b) However, if it is done by the player/s in such a way that rearrangement of the C/m becomes impossible, he shall lose the entire Board with the number of C/m lying on the C/B with the points for the Queen as per the Laws.



- 135) The run of the Striker shall not be tested on the playing surface during the course of a Board.
- 136) a) The player shall not keep his Striker on the frame or in the pocket of the C/B during the Board.
b) However, the player shall be permitted to place the Striker and/or C/m on the playing surface of the C/B, near his base lines only, while placing the Due and/or penalty C/m.
- 137) If the players pass over their turn consecutively for 3 times each, that particular Board shall be cancelled and be replayed.
- 138) There shall be an interval of 10 minutes in between the second and third games.
- 139) A player is permitted to concede a game and/or match at any stage.
- 140) In case of any unforeseen circumstances beyond the control of the Umpire that particular Board shall be replayed.
- 141) If a C/m is damaged by a stroke during the course of the Board, the position of the bigger part of the damaged C/m is considered for all purposes and the Umpire's decision shall be final.
- 142) In the event of the C/m lying on the Base lines/Base Circles, preventing the player from taking a stroke for want of space for placement of his Striker, that Board shall be replayed.



- 127) a) A stroke shall be considered to have been made, if the Striker slips, leaving any Base Line or Base Circle, irrespective of whether it has touched any C/m or not.
b) However, if the Striker slips and does not leave any Base Line or Base Circle or moves any C/m, stroke shall not be considered to have been made.
- 128) A player may find out the score from the Umpire only during his turn of play.
- 129) A player shall not distract the attention of the opponent by any act.
- 130) a) While taking a stroke, the Striker must touch both the Base Lines.
b) If the Stroke is made from the Base Circle, the Striker must cover the Base Circle fully but shall not touch the arrow.
- 131) In doubles, during the course of a Board, the partners are not allowed to talk or communicate with each other by gestures. Any violation in this regard shall be penalised with a Foul as per Laws.
- 132) Players shall not talk to the spectators during the course of a game without the permission of the Umpire.
- 133) The player shall not hold any solid material(s), except the Striker in either hand during the course of his turn.
- 134) The C/m and/or Queen shall not be moved or disturbed after the Break, except by way of a stroke. If touched, moved or disturbed the same shall be replaced in the original position by the Umpire, as far as possible and a Foul shall be declared against the offending player as per the Laws.



XVII. LOSS OF ENTIRE MATCH

- 143) A player shall be liable to lose the entire match for any act of indiscipline and/or any of the following:
 - a) Leaves match board area (3.05 meters) during the game without the permission of the Umpire.
 - b) Fails to abide by the time limit given for the rest in the deciding game during a match.
 - c) Refuses to abide by the decision of the Umpire and/or Chief Referee.
 - d) Passes insulting remarks against the Umpire, Chief Referee and/or authorities before or during or immediately after the match.
 - e) Smokes or smells Foul while at play due to intoxicating drinks and/or is under the influence of drugs.
 - f) Plays with an uncertified Striker.
 - g) Discontinues play during the course of a match, without the permission of the Umpire.
 - h) Disturbs and distracts the attention of the opponent while at play more than twice, despite Umpire's warning.
 - i) Fails to report to the Umpire at his match Board within 15 minutes after the match is announced.



XVIII. PROTEST

- 144) All protests shall be written in English addressed to the Secretary of the tournament and shall be submitted through the Chief Referee/ Umpire duly signed by the player/Captain or the Manager of the team.
- 145) The oral protest shall be intimated to the Umpire immediately after the incident takes place along with the prescribed scrutiny fee. No protest shall be entertained without payment of scrutiny fee.
- 146) The written protest shall be submitted within 15 minutes of completion of that particular Board.
- 147) The protest shall represent facts only, as had occurred, the decision of the Chief Referee/Umpire and the point appealed against by the aggrieved party.
- 148) Protest in uncouth and abusive language shall be summarily rejected and invite disciplinary action.
- 149) Once a protest is lodged, it shall not be permitted to be withdrawn.
- 150) Once a protest is recorded and handed over, the play shall continue from where it stopped. The result of the match shall not be announced till the protest is considered.
- 151) a) If the protest is upheld, the match shall continue from the beginning of that particular board in which the protest was lodged and the scrutiny fee refunded.
b) In case the protest is overruled, the result already obtained shall stand and the scrutiny fee forfeited.
c) The decision of the Championship/Tournament authorities should be conveyed to the parties concerned within one hour from the time the protest was lodged.

XIX.

SCORE CARD

CHAMPIONSHIP/ TOURNAMENT
EVENT ROUND DATE TIME
MATCH NO. UMPIRE C/B No.
TOSS WON BY CHOICE OF TOSS WINNER

Game No.	Starting Time	Finishing Time	Player/s Name				Player/s Name		
1.				
2.				
3.			Team				Team		
Game No.	Board No.	1 Break By	2 Queen	3 No. of c/m	4 Grand Total	5 Queen	6 No. of c/m	7 Grand Total	
1.									
2.									
3.									
4.									
5.									
6.									
7.									
8.									

Remarks of the Umpire
Match won by Loser's Signature Umpire's Signature
Column (1) Name of the player choosing to break is to be entered first.
Column (2) & (5) Three points are to be entered for the player pocketing the queen and 'Nil' in the other "Queen" Column.
Column (3) & (6) The number of C/m of the opponent/s lying at the finish of the board is to be noted and 'Nil' in the other column 'No. of C/m.'
Column (4) & (7) The aggregate number of points secured by the player/s cumulatively is to be entered at the finish of each Board.



Notes



Notes

FIRST EDITION 1993
SECOND EDITION 2001
THIRD EDITION 2004

Published by the

International Carrom Federation

D-92, MMTC Colony, Sri Aurobindo Marg,
New Delhi-110017 India

Phone : +91-11-26569090

Mobile : +91-9810244857

© Copyright

International Carrom Federation

No portion of this book may be reproduced or copied or translated in any form or by any means without the written permission of the I. C. F.

International Carrom Federation was formed on
15th October 1988 in India.

For enquiries & suggestions

contact

Krishan K. Sharma

President

International Carrom Federation

11 Orchard Way, Leagrave

Luton LU4 9LT, Bedfordshire, U.K.

Phone & Fax : 0044 (0) 1582-584702

Mobile : 07970000707

E-mail : krishan.k.sharma@btinternet.com

S.K. Sharma

Secretary General

International Carrom Federation

D-92, MMTC Colony, Sri Aurobindo Marg,

New Delhi-110017 INDIA

Phone : +91-11-26569090

Mobile : +91-9810244857

E-mail : icf_sk@yahoo.co.in, aicfsks@indiatimes.com